

USE AND INSTRUCTION MANUAL



AGRILITE 



AGRILITE YF 



Code no. SCR300R / SCR300H / SCR302R / SCR302H
Manual Ver. 2.0 - FW Ver. 5.X.X

Contents

1.1 Compliance and scrapping instructions

1.1.1 Safety Notes

1.1.2 Safety Advices

1.2.1 Unpacking

1.2.3 Hoses connection

1.2.4 Internal bottle refill

1.3 Unit description

1.3.1 User panel

2.0 Oksygen+ App download

2.0.1 Oksygen+ registration

2.1 Startup initialization

2.2 Main screen

2.3 Main Menu

3.1 Database

3.2 Database selection

3.3 Model selection

3.4 Type Selection

4.1 Automatic AC Service phases

4.1.1 Input data edit

4.1.2 Service Resume

4.1.3 Quick couplers connection

4.2 Automatic Service

4.3 Recovery

4.4 Oil Drain

4.6 Vacuum

4.7 Vacuum Test

4.8 Oil Injection

4.9 Dye Injection

4.10 Refilling Test

4.11 Gas Refilling

5.0 Accessories

5.1 Flushing

5.2 Easyflush

5.4 A/C Leaks Detection

5.5 Gas Analysis

6.0 Reports

6.1 Last A/C Service

6.2 A/C Services

6.3 Reset Counters

7.1 Bottle Refill

7.2 Self Cleaning

7.3 Decontamination

7.4 Weight Test

8.0 Setup

8.1 Date Time

8.2 Language

8.3 LCD Setting

8.4 Working Setup

8.4.1 Recovery Check

8.4.1 Recovery Check

8.4.2 Vacuum Test

8.4.3 Extra Oil

8.5 Hoses Length

8.6 Print Fluid

8.8 Info

9 Ordinary Maintenance

10 CE-Declaration

1.1 Compliance and scrapping instructions



COMPLIANCES

The unit described in the present manual has been designed, manufactured and distributed meeting in full the essential requirements specified by the following European Directives concerning safety of machinery, safety of low voltage electrical apparatus and electro-magnetic compatibility:

MACHINERY DIRECTIVE (2006/42/CE);

LOW VOLTAGE DIRECTIVE (2006/95/CE);

ELECTROMAGNETIC COMPATIBILITY DIRECTIVE (2004/108/CE)

The conformity is declared with reference to the following harmonized standards:

EN 61010-1:2010; EN 62233 :2008

EN 61000-6-1:2007; EN 61000-6-3:2007;

EN 61326-1:2007

EN 61000-3-2 :2006/A1:2009/A2:2009; EN 61000-3-3:2008

The machines are built according to RoHS European Directive requirements (2002/95/CE).

SCRAPPING

- Do not treat the unit as mixed solid waste for scrapping but take it into pieces (waste separation).
- Refer to the specific collection points for waste of electric and electronic devices (AEE), according to the relevant CEE RAEE 2002/95/EC, 2002/96/EC, 2003/108/EC regulation.
- The vacuum pump and the containers of new and used oil contain mineral and synthetic oil. Therefore, specific regulations for scrapping have to be followed. The same procedure has to be followed for refrigerant gas residuals in the storage bottle. Also the exhaust oil drained from the pump is a specific waste and has to be collected according to the relevant regulations in force.

1.1.1 Safety Notes

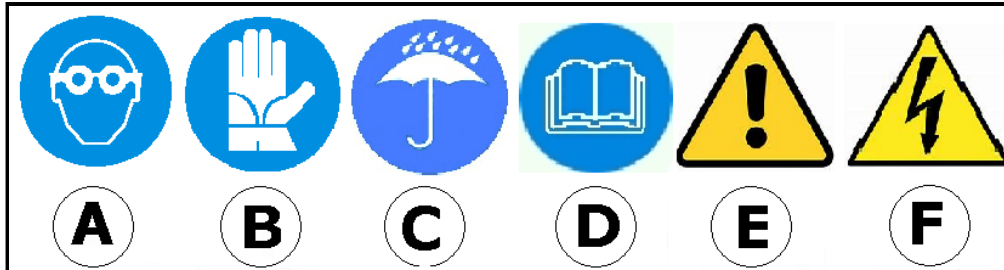

SAFETY ICONS

The meaning of the icons used in the present manual and on the unit is explained here after:

- A) Wear goggles when handling refrigerants
- B) Wear gloves when handling refrigerants
- C) Protect the unit against humidity
- D) Read the instructions manual carefully
- E) Caution!
- F) Electrical shock hazard! De-energize the power source before servicing

PRELIMINARY INSTRUCTIONS

The present recycling and recharging unit for A/C systems is meant for commercial purposes and is thought to be used by trained personnel only being aware of the principles of refrigeration, conscious of the hazards which may derive from equipment working under pressure with substances at very low boiling temperature (at 1,013 bar, the R134a boiling point is $-26,1\text{ C}^{\circ}$, 1234yf the boiling point is $-29,4\text{ C}^{\circ}$)

We advise to read the present instruction manual carefully and to strictly comply with the given information, paying particular attention to the safety regulations. We shall decline any responsibility resulting from the improper use of the equipment, use for purposes other than those described in the present operating manual, incorrect operations, damages resulting from external influences.

Always keep the unit in vertical position in order to avoid oil leaks and the compressor to be damaged

SAFETY DEVICES

The unit is equipped with following safety devices:

- A) Pressure relief valve on internal gas tank: releases pressure if 18 Bar are exceeded in the gas tank. The purpose of the valve is to ensure that the max pressure inside the tank does not exceed the max operating pressure for which the tank has been designed . It is forbidden to intervene on this valve, always contact specialized and authorized personnel in case of malfunctioning.
- B) Safety fan: ventilates the unit continuously when in use. The software displays a warning in case of fan failure. This device applies to R1234YF refrigerant models only
- C) Front wheels with brakes



1.1.2 Safety Advices

Please follow the below safety advices to limit possible risks:

- Read the instructions for use carefully before starting to operate with this Aircon service unit.
- Follow the information and the instructions of the refrigerant manufacturer.
- Observe any instructions on servicing vehicle A/C systems which apply at your company.
- Use with refrigerant indicated on the data plate only (HFO-1234YF or R134a).
- Do not make modifications to the service unit.
- Only employ original spare parts and accessories.
- Use authorized additives or consumables only (ask for advice from an authorized reseller).
- Before starting the machine first check each time whether the charging hoses and the quick couplers are undamaged and are not leaking.
- Recover refrigerant from the hoses before releasing the quick connections.
- Do not leave the unit unattended when switched on. Use the main switch to switch off the unit after its use.
- Always wear personal safety equipment, in particular gloves and protective goggles apart from following the general safety rules which apply to your company.
- Avoid inhaling the refrigerating gas.
- Avoid the contact with the skin by refrigerating gas, danger of freezing.
- Never abandon the refrigerating gas in the environment.
- Do not use the unit in potentially explosive environments (for instance: battery charging rooms).
- Do not smoke whilst using the recharging unit.
- During the operations, locate the unit on a flat and leveled surface.
- Do not use the unit near flames or sources of heat; at high temperatures the refrigerating gas can generate poisonous substances for inhalation.
- Do not use the unit in very humid and wet environments or in the rain.
- Use the unit in airy environments.
- During maintenance operations disconnect the unit from the electrical power.
- Avoid removing the connecting hoses if not necessary; in case always make a vacuum in the hoses before using again.
- Maintenance operations have to be carried out by specialized and authorized personnel.
- Do not violate for any reason at all the safety devices the unit is equipped with, like the high pressure valve of the internal tank.
- Do not fill compressed air in the lines of the service unit or in the vehicle aircon system (a mixture of air and refrigerant can be flammable or explosive).

Please be aware that whatsoever damages due to a wrong or improper use of the recharging station will not be covered by our warranty. Consumables like packing and seals for hoses and quick couplings, fuses and damages occurred during transport are not part of the warranty.

1.2.1 Unpacking

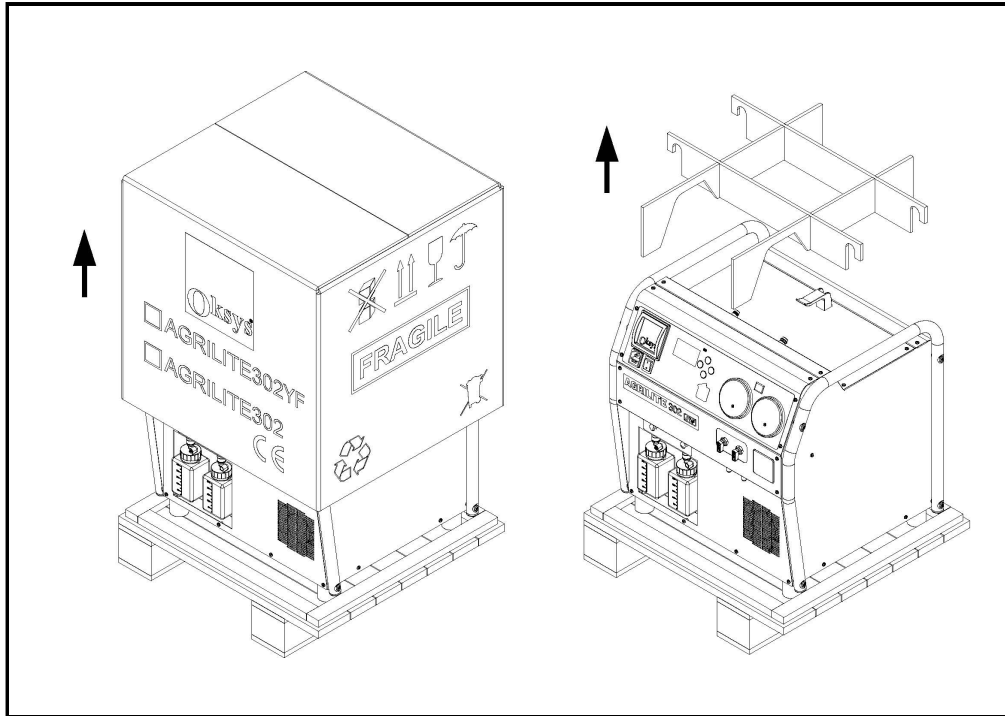

Check the integrity of the packaging to exclude damages occurred during transport.
If present on your packages, check the integrity of the "TILTWATCH" indicator (If the indicator has turned red, follow the relevant instructions).
Check the entirety of the equipment and of the relevant accessories.
Not conformities, if any, have to be pointed out immediately and written on the transport documents.
Keep the package with care and re-use it for future transportations.

1.2.3 Hoses connection



Connect the charging hoses to the unit (high pressure = RED, low pressure = BLUE). Make sure that the quick couplings are in CLOSED position (turn counterclockwise to close the coupling, see picture)

Carry out a vacuum cycle of one/two minutes followed by a leak test under vacuum. The above procedure avoids that air residuals are left in the hoses and checks for eventual leaks (see the relevant instructions). The vacuum and the following leak test should be repeated whenever the charging hoses could have been contaminated with air.

Check if the setting relevant to the length of the hoses is correct (select SETTINGS, then HOSE LENGTH and modify if needed, by means of the buttons UP and DOWN).

If the hose length is set to 0 (zero), at the end of the working cycle, the unit will not calculate the gas remaining in the hoses at the end of the working cycle and will lead the user to suction the gas residuals in the A/C system of the vehicle, instead.

(In case of a pressure test, which is not preceded by a standard working cycle, the unit recovers the gas residuals in the vehicle by default, regardless to the above setting)

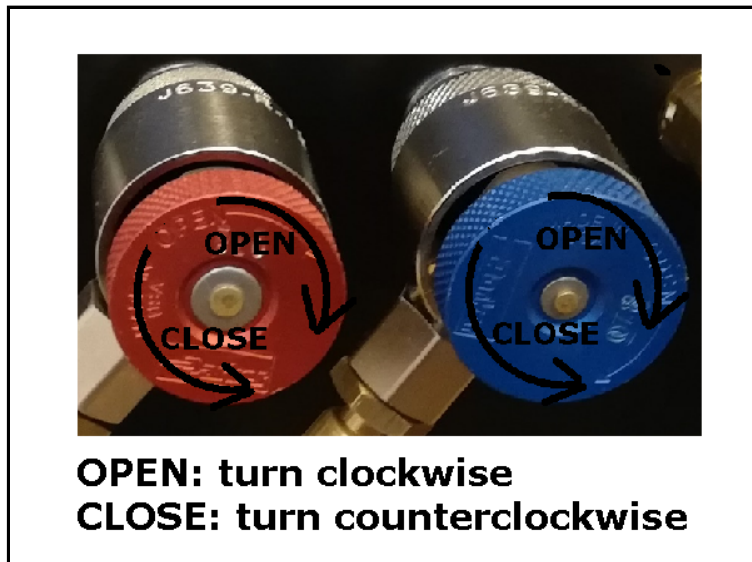

1.2.4 Internal bottle refill



The unit is delivered with the empty internal gas bottle for safety reasons. It is therefore necessary to fill the bottle with a refrigerant quantity not lower than 2 Kg and not higher than eighty percent of the maximum nominal capacity of the tank (this percentage may change according to local safety rules). In order to fill the internal tank please follow the relevant instructions of the present manual. To connect to the bottle, use the HP hose with the HP quick coupling (a special coupling is required to couple the quick coupling to the bottle, see hereunder).



Adapter for R134a bottles
code ACC-88.011+ACC-88.072



Adapter for R1234YF bottles
code ACC-88.289H

1.3 Unit description

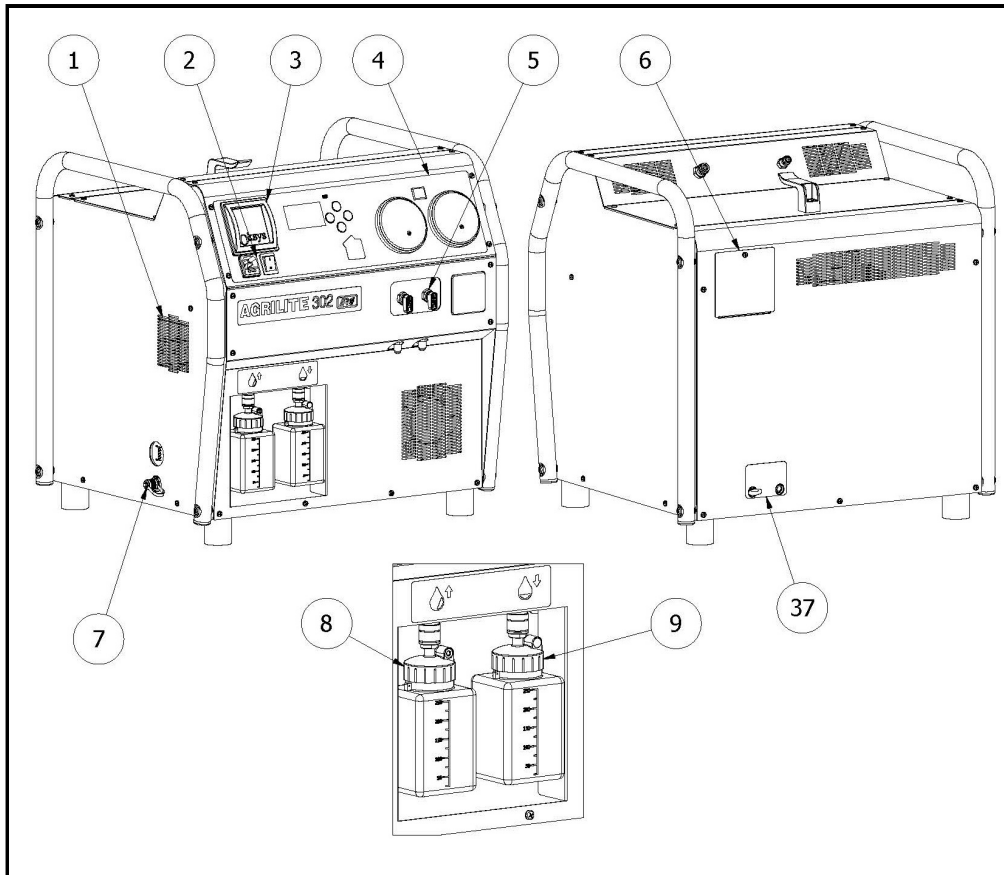

legenda:

- 1) Ventilation grid
- 2) Main switch
- 3) printer housing
- 4) User panel with pressure gauges
- 5) LP and HP taps
- 6) Inspection door
- 7) Vacuum pump oil drain
- 8) New oil bottle
- 9) Oil drain bott
- 37) Scale block / calibrat

1.3.1 User panel

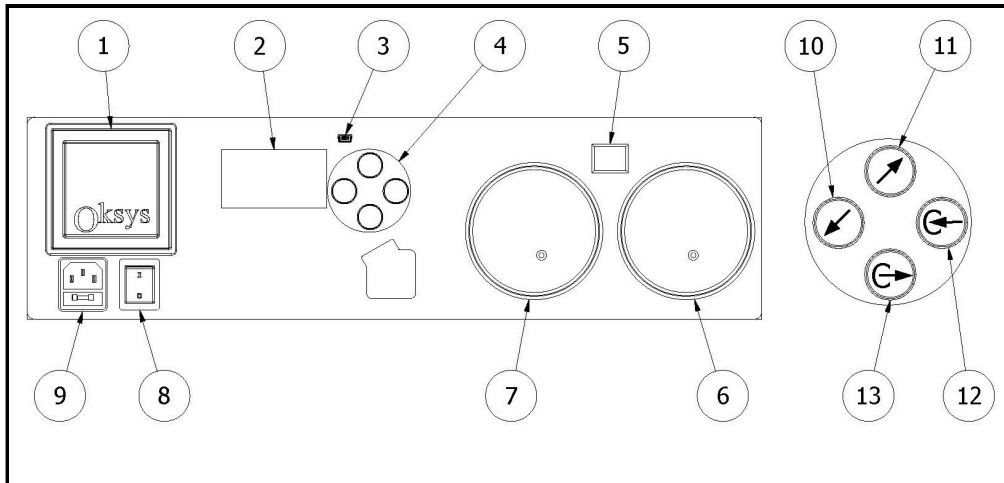

The picture above shows the user panel that allows to control the functions of the unit.

Legenda:

- 1) Thermal printer housing (optional)
- 2) LCD Display
- 3) USB mini port
- 4) Control buttons
- 5) Bluetooth antenna (optional)
- 6) High pressure gauge
- 7) Low pressure gauge
- 8) Main switch
- 9) Power socket
- 10) Arrow DOWN (decrease)
- 11) Arrow UP (increase)
- 12) Button ENTER
- 13) Button EXIT

2.0 Oksygen+ App download

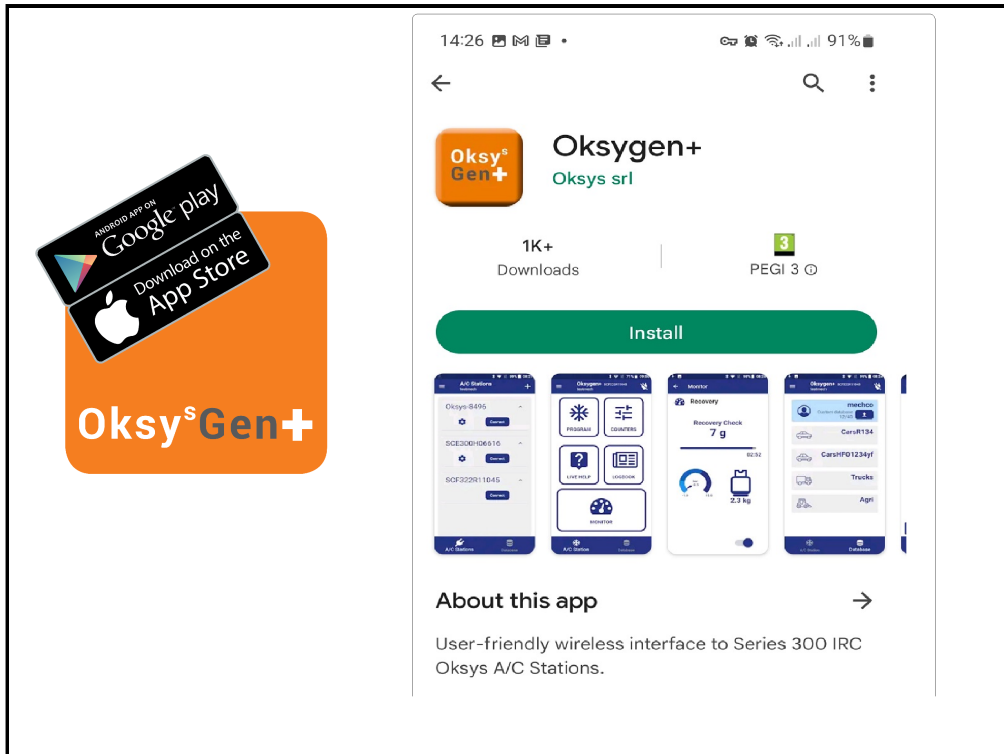

Download the OksyGen+ app from Playstore (Android devices) or App Store (IOS devices) to remotely control the unit and profit from the advanced features of the units of 300 "IRC" series

Register the App at first use by typing or scanning the Serial number of your unit.
Complete the registration by typing the requested data.



2.0.1 Oksygen+ registration

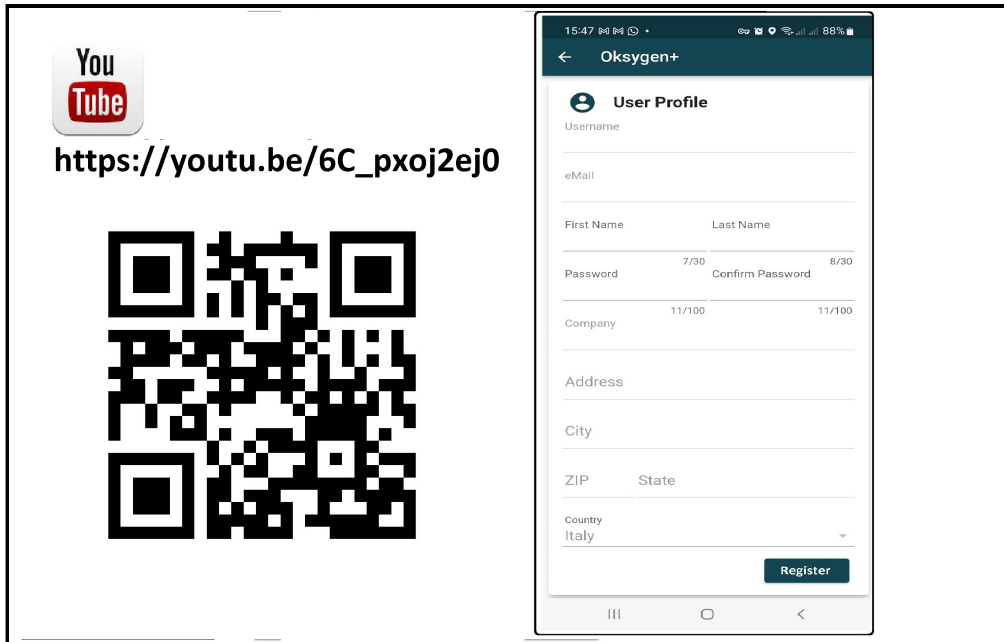

Complete the user profile and click on "register user"
Connect to the unit and use the app; Explore the various possibilities to facilitate and complete the use of the machine with the help of the Oksygen + App

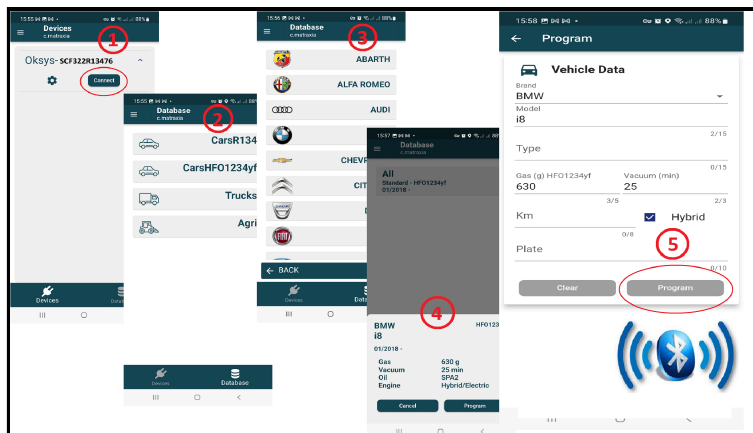

2.1 Startup initialization



When the machine is switched on, the type, the SW version and the last five digits of the serial number of the machine are shown on the display.

At the same time the internal Bluetooth antenna is initialized to make it possible to connect with the help of the Oksystool (Service personnel) or OksyGen (users) apps. The unit further performs a series of tests to check its functionality and the absence of leaks in the internal circuits: an internal cleaning is performed including an exhaust OIL DRAIN and an INTERNAL VACUUM phase.

2.2 Main screen



The main system panel appears just after the start up procedure.

A number of information are displayed, like the refrigerant quantity stocked into the internal tank as well as the refrigerant temperature.

This in turn gives the calculated tank pressure also displayed. Before starting to use the system, compare this pressure with the actual pressure you can read on the orange gauge.

If the actual tank pressure is well lower than the calculated tank pressure, then a quantity of not condensable gas is present inside the tank. In the case, provide to purge the tank.

A notifications panel including the count down to the system regular services, is available on this screen. Depending on the unit model press ESC to activate the notification panel. Press UP and DOWN to scroll the active notification list and ENTER to open the main menu.

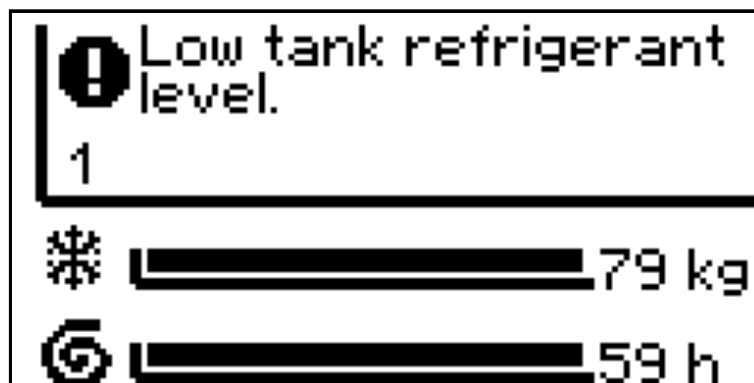

2.3 Main Menu

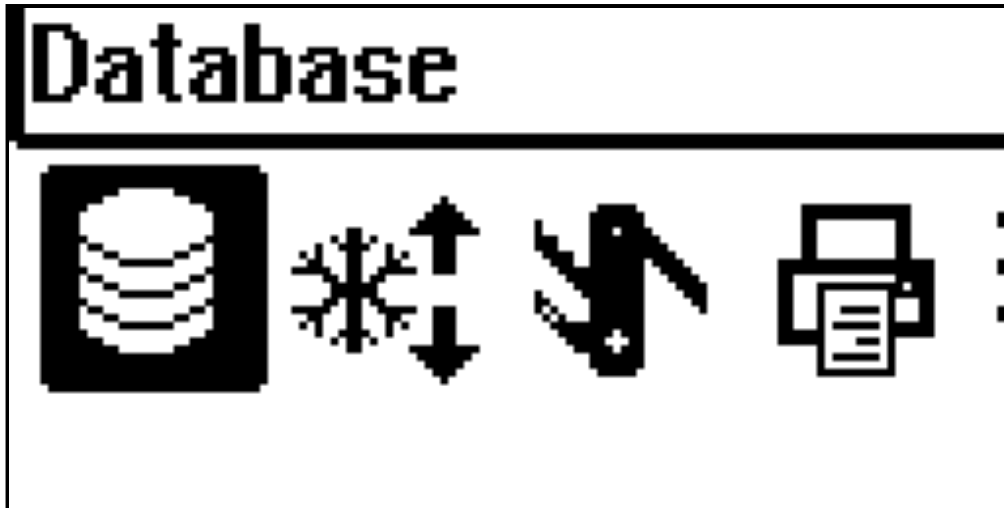

The main menu provides the access to all functions as well as the setting of the A/C service unit.

The currently selected function is displayed in the title area while the corresponding icon is highlighted.

While it makes sense for a particular function, the most significant input data value is displayed below the icon.

Three dots on the left or right side of the screen means the menu includes more functions by scrolling toward that side.

Press the UP and DOWN buttons to change the selection through the functions and press ENTER to enter the function menu.

3.1 Database



The database function allows the user to configure the service unit to perform the standard recovery-recharge service suited for a specified vehicle. A multilevel selection is provided to get the information related to the A/C system of the vehicle. The first level selects from the currently installed databases.

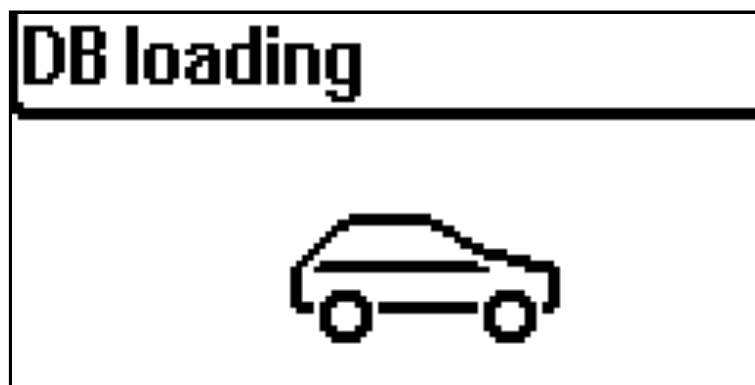

3.2 Database selection



The database function allows the user to configure the service unit to perform the standard recovery-recharge service suited for a specified vehicle. A multilevel selection is provided to get the information related to the A/C system of the vehicle. The first level selects from the currently installed databases.

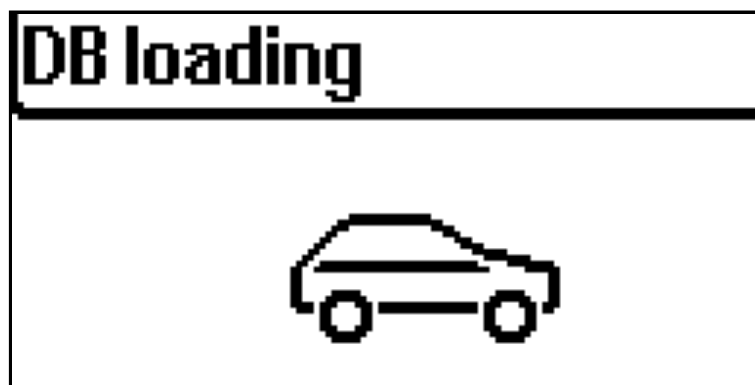

3.3 Model selection



BRANDS

The brand list included in the selected database can be scrolled with this function to look for the required one.

Press UP and DOWN to scroll the list and ENTER to open the models list related to the currently selected brand.

MODELS

This level browses to the vehicles model list related to the selected brand of the loaded database.

Press UP and DOWN to scroll the list and ENTER to open the list of all the A/C systems provided for the currently selected vehicle model.



3.4 Type Selection

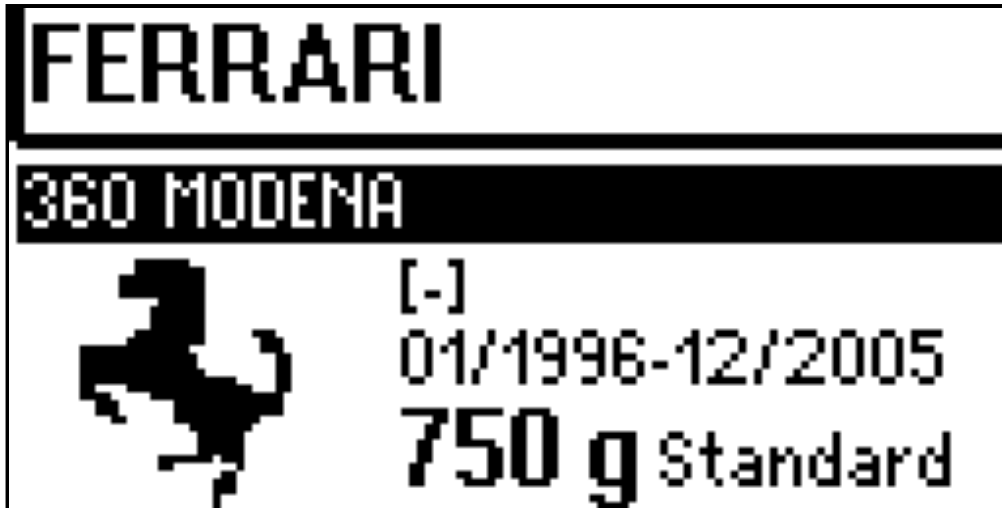

This is the deeper level of selection within a database. A number of A/C system types may have been installed on a vehicle depending on the vehicle setting up or the production period.

Whenever it is significant, the name of the A/C system as well as the production period are displayed.

This information will help you to select the right A/C setting data.

Other information may be displayed like the A/C compressor oil recommended from the vehicle manufacturer, the type of vehicle engine (Standard or Hybrid that include the pure electric vehicles) and the positions of the connection for the service unit quick couplers.

Finally the quantity of refrigerant suited for the selected A/C system is displayed.

Press UP and DOWN to scroll the A/C systems list provided for the selected vehicle and ENTER to configure the service unit and move directly to the A/C service function..

4.1 Automatic AC Service phases

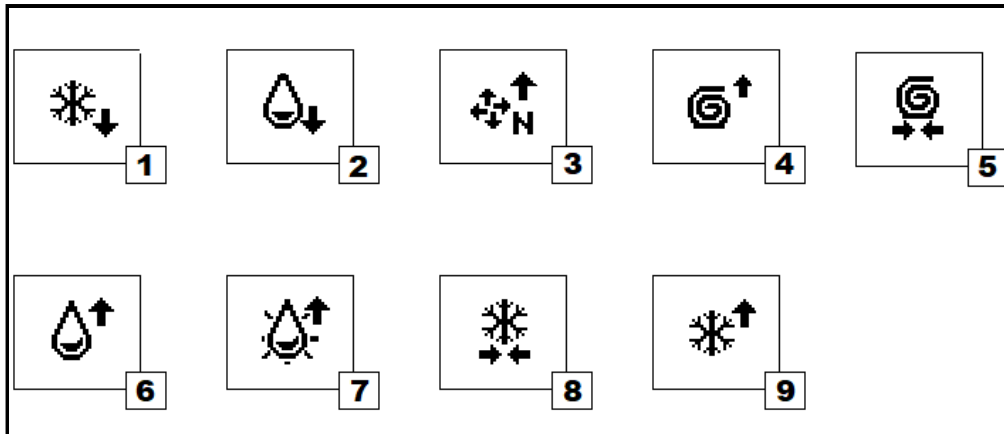

The standard sequence of the A/C system service includes:

- 1) Refrigerant recovery
- 2) Exhaust oil drain
- 3) Stress test under nitrogen (if provided by the service unit)
- 4) Vacuum
- 5) Vacuum test
- 6) Oil refill
- 7) Dye refill (if provided by the service unit)
- 8) Charge trial (provided only in the HFO1234yf service units)
- 9) Refrigerant charge

The number of functions may change depending on the unit model or on the installed options.

4.1.1 Input data edit

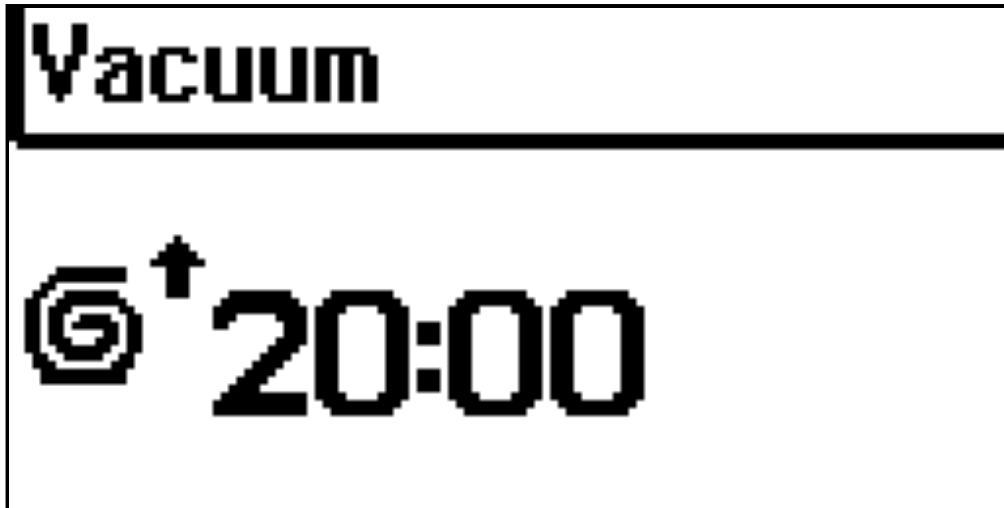

Some service procedures require an input data to be changed. A zero value for the inputs data means that the correspondent procedure will be not executed.

In the shown examples, the VACUUM service requires the user to change the vacuum time while the CHARGE service requires the quantity of refrigerant to be charged. Press UP and DOWN to change the input value, ESC to confirm the value and move back to the A/C Service menu. Press RETURN to confirm the value and begin this single service.



4.1.2 Service Resume

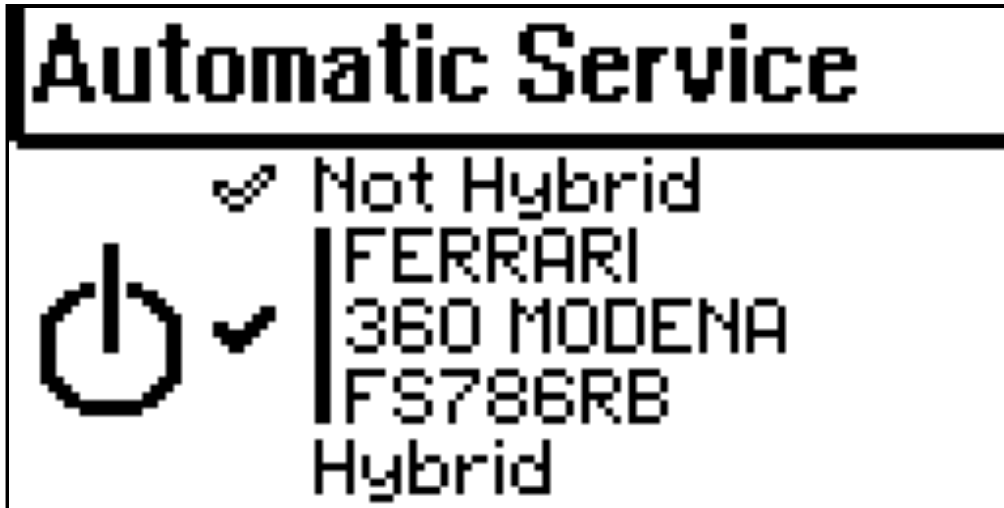

Regardless of the A/C service type, before starting any procedure, the system shows the user a resume screen.

The screen shows the service type, the current vehicle brand and model and the technology of vehicle engine: standard or hybrid/electric.

Press ENTER to confirm the current vehicle or press UP and DOWN to change to a "not specified vehicle" with a standard or hybrid/electric engine.

In case of a service on a hybrid/electric vehicle and if it not yet done, the system will prompt for an oil decontamination procedure.

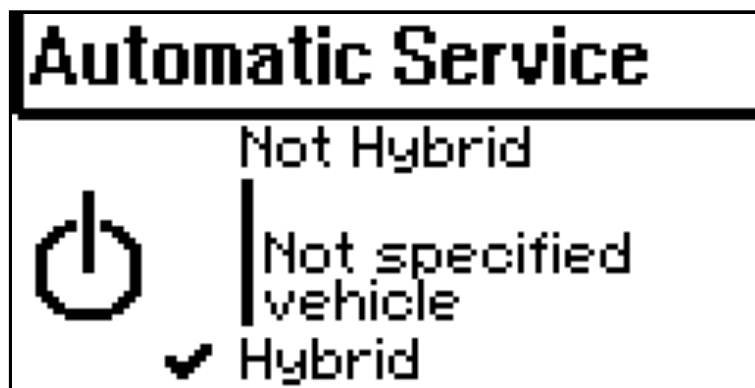

4.1.3 Quick couplers connection

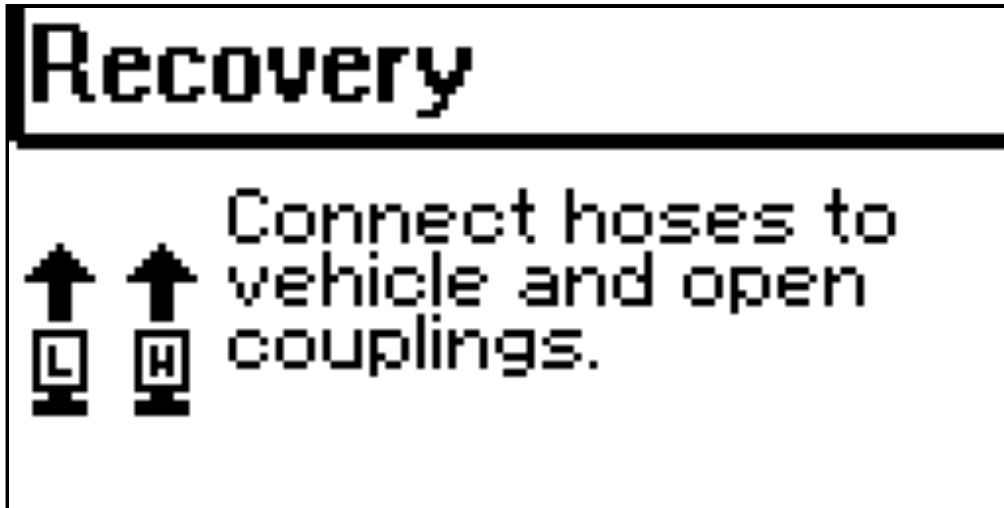

The system asks the user to connect the charging hoses to the vehicle/the external bottle/the AC component to be flushed (depending from the current procedure) and "open" the relevant quick couplers. To "open" the couplers, turn the knob clockwise, to "close" them turn it counterclockwise.

In case of connection to a vehicle and if this data is available, the position of the couplings in the engine compartment will be displayed on the right of the display.

The title bar displays the currently selected procedure.

Whenever it make sense, by pushing the UP and DOWN buttons, the user may set the unit to use one of the two lines (HP and LP) or one of them only.

As the couplers are open, the pressure gauges will display the pressures of the connected vehicle/bottle.

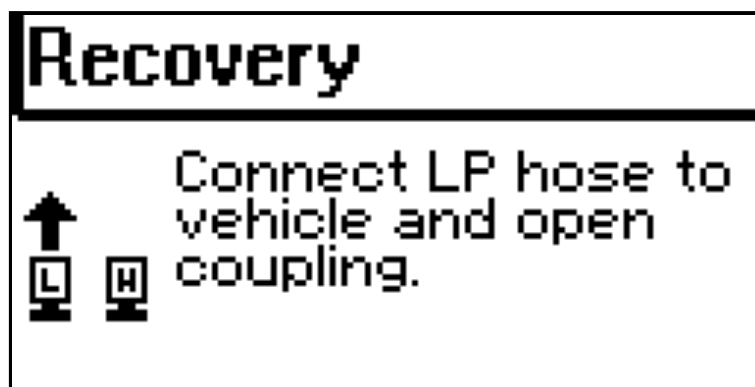

4.2 Automatic Service



AUTOMATIC SERVICE

The function start the full automatic A/C services sequence to be performed automatically

An input data set to zero means that the related step will be skipped.

If the system detects a condition which prevents the operation, it displays an error message. The sequence will be interrupted and the final hoses recovery procedure will be proposed.

Whenever it makes sense, the input value is displayed under the icon of the related service.

An input data value set to zero means that the related service will be skipped.

SINGLE SERVICE STEP

Press UP and DOWN to select a service function and ENTER to start the relevant procedure.

The single functions may be performed individually or in a full automatic service sequence.

Select the left most function to start the full automatic A/C services sequence or any of the other functions to perform only the relevant procedure.

Press ESC to break the working procedure without any regard of the progress.

If the system will detect a condition that hamper to proceed, the sequence will be interrupted and the final hoses recovery procedure will be proposed.

4.3 Recovery

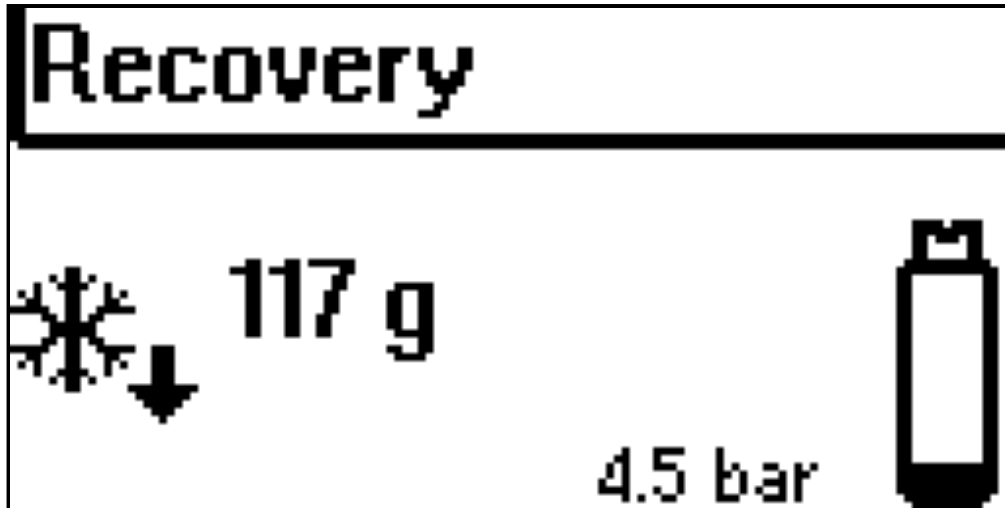

During this phase, the system recovers the refrigerant from the A/C system and stores it into the internal tank.

As the pressure in the internal lines and in the vehicle decreases and reaches the lower limit, the compressor stops. The unit checks if the pressure increases (meaning that refrigerant residuals have still to be recovered from the vehicle) and, in case, performs a new recovery cycle. The procedure ends definitively when the pressure stabilizes on the lower values.



4.4 Oil Drain

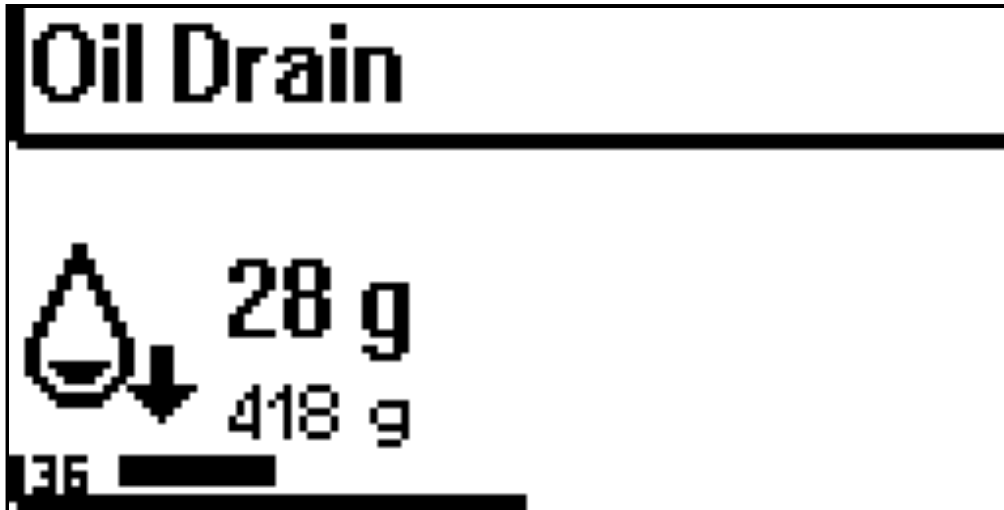

If at least 50 g of refrigerant have been recovered, the Drain procedure starts automatically just after the Refrigerant Recovery procedure. The screen displays the draining oil quantity and the recovered refrigerant quantity. The procedure is skipped for low quantities of recovered refrigerant.

4.6 Vacuum

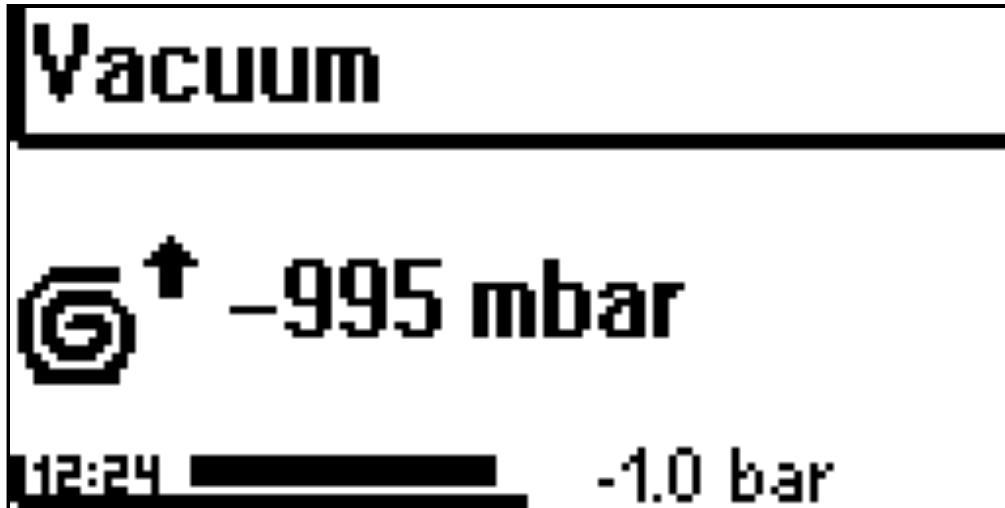

The VACUUM procedure allows to remove air and humidity traces by the A/C system. It is strongly recommended to have a convenient long VACUUM specially whenever the A/C system has been opened for example to change a component. If the procedure cannot reach a good vacuum pressure, than it will stop indicating a potential leakage in the A/C system. As the programmed vacuum time expires, the VACUUM TEST procedure will start automatically if the related parameter is not set to zero.

4.7 Vacuum Test

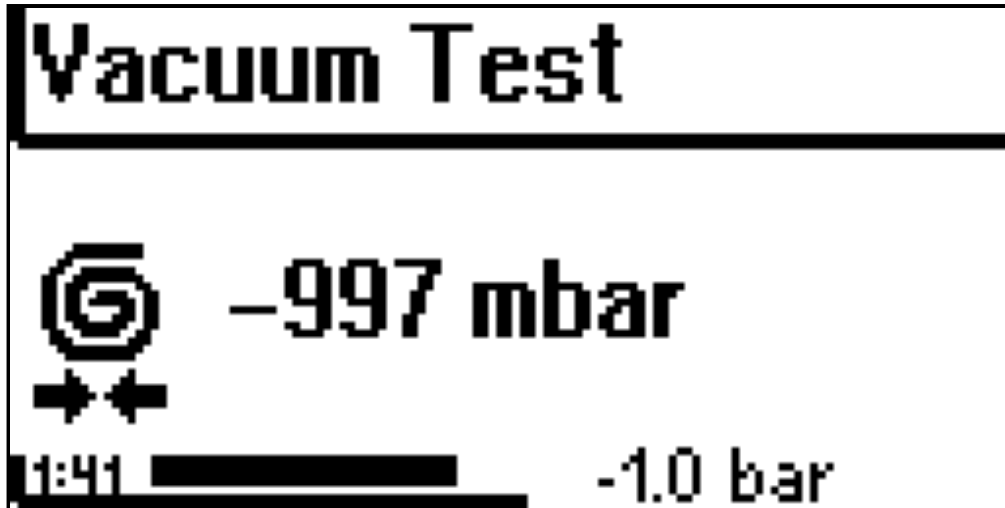

The VACUUM TEST procedure starts automatically after the VACUUM procedure. This procedure tests for the vacuum pressure will persist on the A/C sytem for a defined test time.

If the A/C system pressure increases, the system will advice about a potential leakage in the A/C system.

The test time is set through the menu SETUP -> WORKING SETUP -> VACUUM TEST. It the vacuum test time is set to zero the test will be skipped.

4.8 Oil Injection



The OIL REFILL cycle restores an oil lack into the A/C circuit that could happen as a consequence of a refrigerant recovery.

The oil quantity to be refilled may be set at the beginning of the full automatic service as well as just before the refill cycle is performed. This SEMI-AUTOMATIC MODE allows you to check the quantity of oil drained after the previous refrigerant recovery cycle and set a correspondent value to be refilled.

Set the value to X to get this mode.

Example:

- X means the unit will stop after the vacuum cycle and wait for the setting of the user
- 0 g means the unit will charge no oil
- 5 g means the unit will charge 5 g in the A/C system.

The oil refill is possible only if the A/C system is vacuued and shall be followed by a refrigerant charge.

4.9 Dye Injection

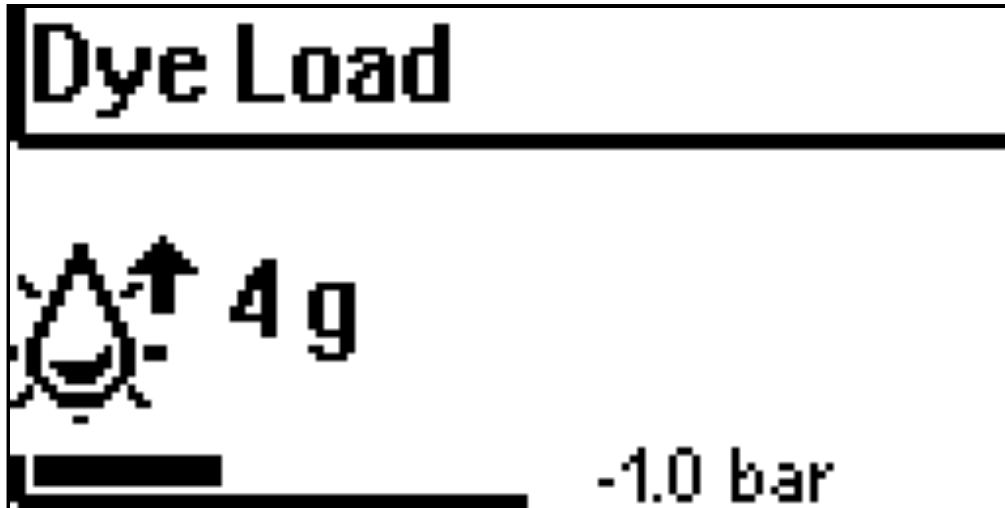

Dye injection adds a pre-defined quantity of special dyeing oil to the A/C system with the purpose of highlight any leaks.

Differently from the other cycles, the dye injection doesn't save the input quantity, so that the value shall be set to a positive quantity every time the cycle is required.

The dye injection is possible only if the A/C system is vacuued and shall be followed by a refrigerant charge.

4.10 Refilling Test

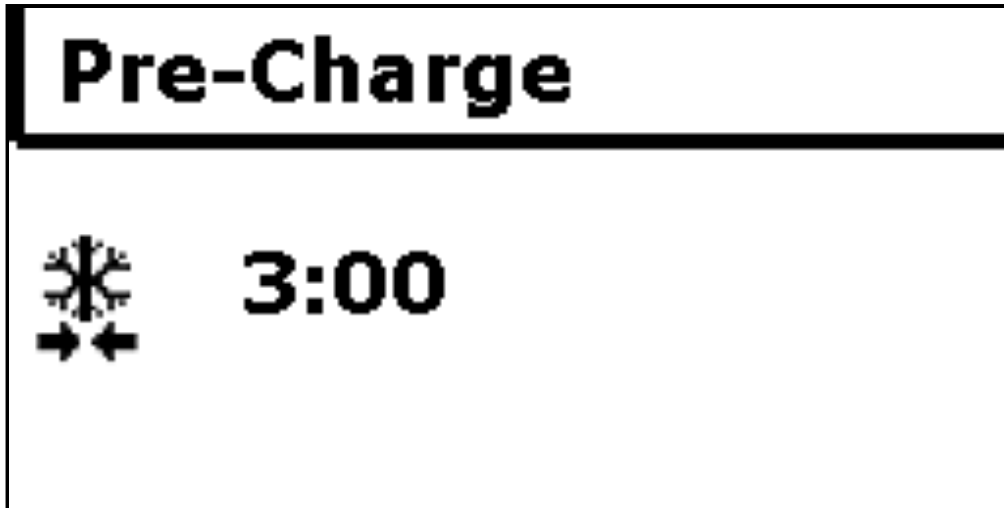

This procedure performs a pre-charge test with a reduced refrigerant quantity (15% of the total quantity) to exclude possible leaks. Once the the refrigerant has been charged, the unit checks for the defined period and control the pressure stability.

As the test period expires, the refrigerant is recovered to the internal tank to avoid error on the accuracy of the next refrigerant charge procedure.

In case it's possible to perform a test under pressure with nitrogen (stress test), the pre-charge cycle will be not necessary.

4.11 Gas Refilling

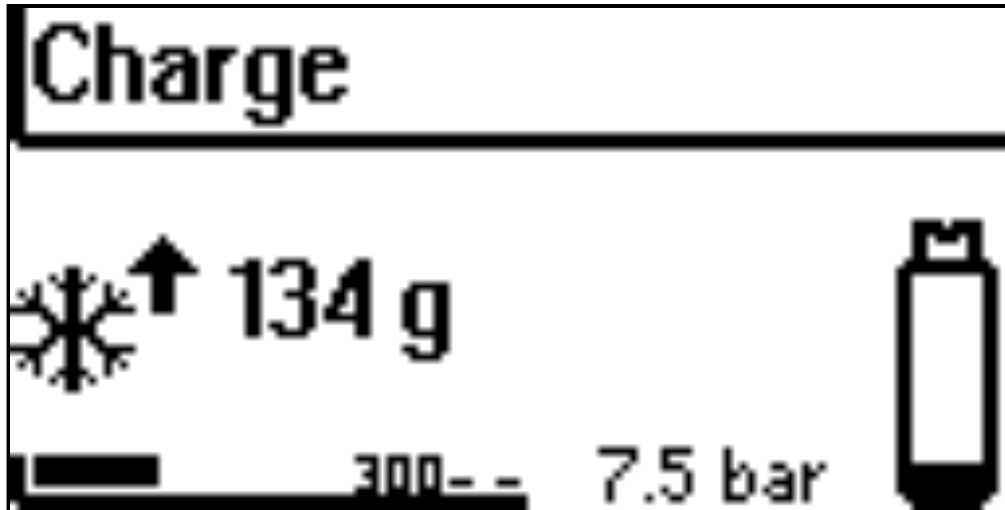

The procedure provides to charge the desired refrigerant quantity in the A/C system. Any previous injection of oil and dye will actually carry inside the A/C system by the fluid refrigerant during this phase.

The quantity which remains in the hoses after the charge cycle is automatically calculated and recovered in the tank. Only if the hose length setting has been set to "0" the unit will guide the user to switch on the A/C system in order to suction these residuals into the A/C system of the vehicle

5.0 Accessories



This menu collects a number of accessory phases that are provided to operate both on the A/C system and the single parts. The set includes a FLUSHING procedure and the so-called EASY FLUSH cycle.

5.1 Flushing



NOTE: this function is not present in this device.

5.2 Easyflush

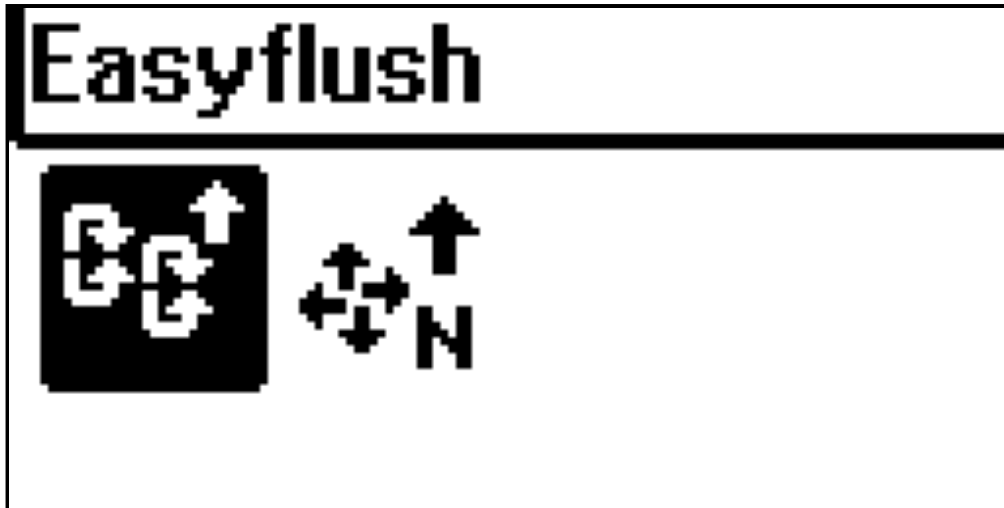

The EASYFLUSH cycle automatically fills and recovers liquid refrigerant into the A/C system (or into parts of it).

To check if the refrigerant (the oil mixed with the refrigerant) is contaminated or not, use the accessory set ACC-EASYFLUSH (not included in the standard outfit)

- Connect the vehicle's A/C system (or part of it) to the unit by means EASYFLUSH accessory kit, as described in the relevant instructions;
- Select EASYFLUSH and set the desired refrigerant quantity (depending on the volume of the part to be flushed)
- press ENTER

Before the flushing, the unit will automatically perform a vacuum cycle to test for any leakage. The vacuum cycle is mandatory to avoid any gas leakage into the environment.

5.4 A/C Leaks Detection



The A/C leak detection cycle allows to test the A/C system with nitrogen/forming gas and check for leaks with the use of an electronic leak detector. To perform the test you will need a Nitrogen/Forming gas bottle (use your own bottle or order code CFU-13.209) a nitrogen test kit (code CFU-NITRO or CFU-NITRO-HD) and a leak detector (code CFU13.209). These accessories are not included in the outfit of the A/C unit and have to be ordered separately. For their use, refer to the instructions supplied with the accessory kits themselves. Connect the nitrogen bottle to the unit , regulate the pressure at 10 Bar (suggested) , set a test time and press on ENTER to start the test. Any pressure decrease (and consequently any leak possibility) will rise a series of warning sounds.

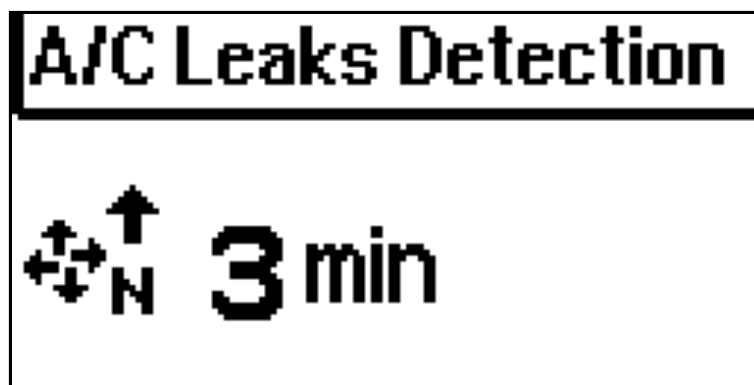

5.5 Gas Analysis



NOTE: this function is not present in this device.

6.0 Reports



The reports menu provides the functions to display and print the report relevant to the service performed with the service unit. A short cut is provided to the last service while a menu allows to seek through the complete services list.

A special report is deputed to display, print and reset a number of counters including all the ones required by the Gas rules.

6.1 Last A/C Service



The unit displays the data relevant to the last A/C service performed by the unit. It is possible to print it (if a printer is present in your unit) by choosing ENTER or return to the previous page by choosing EXIT.

6.2 A/C Services



This function allows to navigate the internal services REGISTRY.
The REGISTRY lists all the services ever performed on this unit, sorted by month.
A single service may be visualized and the receipt may be printed.

6.3 Reset Counters



The function displays the counters relevant to the refrigerant recovered by the unit, the refrigerant and the oil used to fill the vehicles.

Press ENTER to print a receipt. As the printing process is end, the system prompt for a counter reset. Press ENTER to confirm the counter reset and ESC to quit without reset.

7.1 Bottle Refill

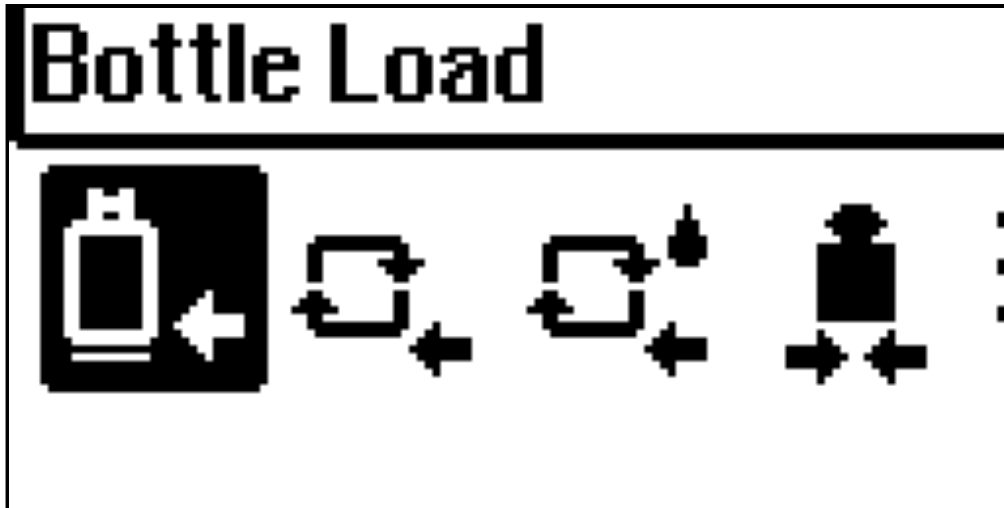

Use this cycle to load or refill the internal tank.

An input data is asked that is the quantity of refrigerant to be loaded. Please consider that depending on the hose length, an higher refrigerant quantity will be loaded. For a length of 3m the final refill will be higher of about 300/400 grams with respect of the set value.

See the instruction in Chapter 1 for more details about this cycle.

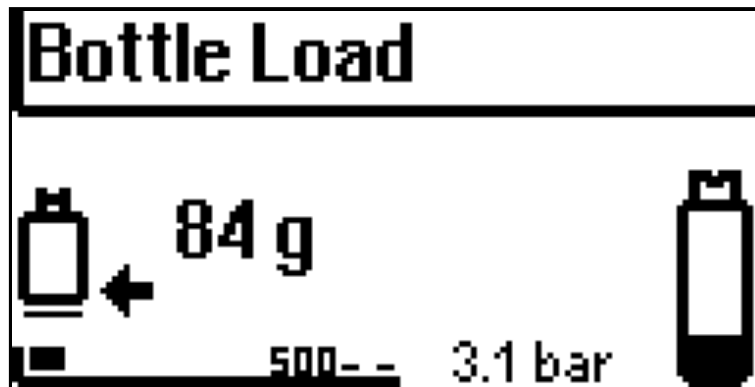

7.2 Self Cleaning



This cycle performs an internal refrigerant flushing with the purpose of clean the internal circuit by removing oil and dirty.

After the flushing, the cycle provides for the oil drain and internal vacuum.

A regular use of the SELF CLEANING cycle, may improve the unit efficiency and life.

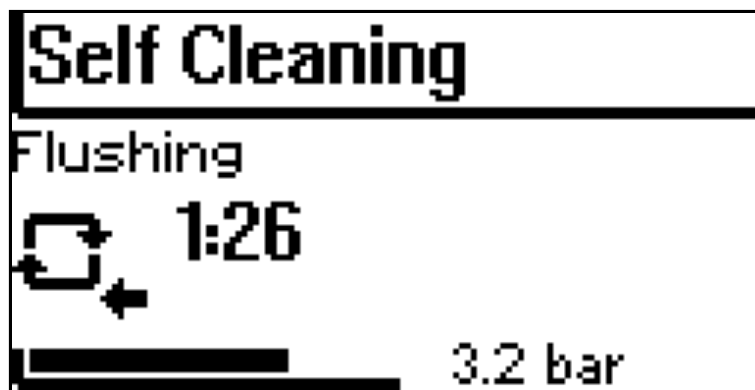

7.3 Decontamination



The DECONTAMINATION cycle is a special self cleaning cycle that allows to prepare the unit to work with a different oil.

With respect the SELF-CLEANING cycle, this one involves also the charge hoses.

Depending on the DYE-HYBRID OIL configuration, the user could be asked to change the oil bottle. In the case the cycle will next provide to prime the internal oil pipe. See the menu SETUP - WORKING SETUP - DYE.

After the above preliminary operations, the system performs three consecutive refrigerant LOAD AND RECOVERY cycles.

Note: the cycle is performed automatically when a service is performed on a hybrid vehicle after the station has been working on a non-hybrid vehicle.



7.4 Weight Test

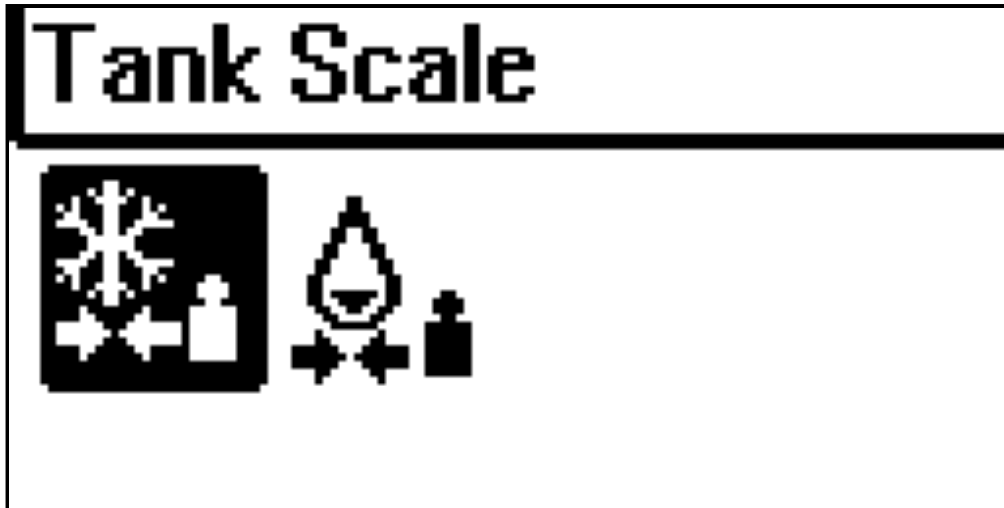

All the unit models are provided with an internal scale for an accurate measurement of the recovered and refilled refrigerant. Depending on the model a further scale is provided to get the value of the drained and refilled oil.

Two procedures are provided to allow to test the scales by checking with a sample weight.

To test the refrigerant scale, put a sample of at least 100 g hanged to the opposite supplied hook.

To test the oil scale, put the sample weight inside an empty oil bottle.

The measured difference is shown on the display.



8.0 Setup

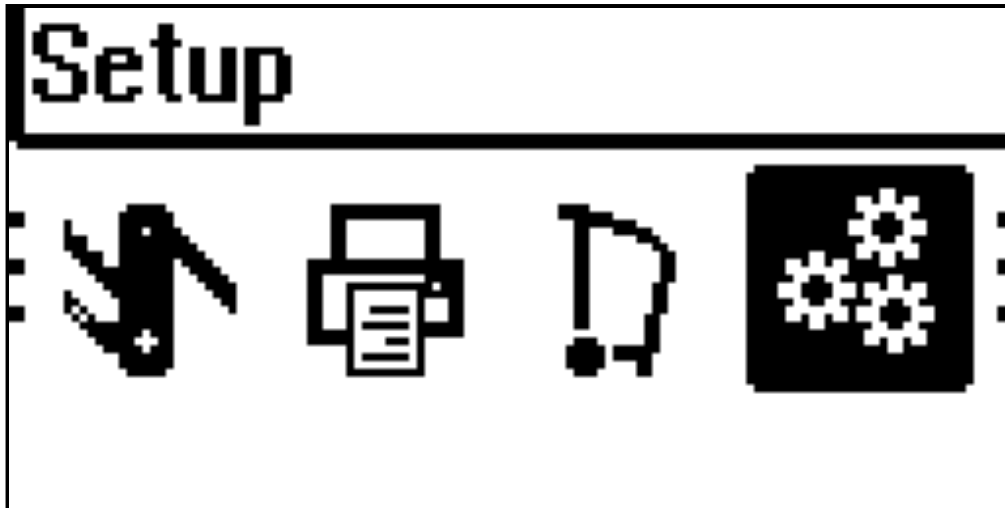

The Set up menu allows the configuration of the service unit. The internal time and the language can be set through this function, as well as a number of parameters that allows the user to trim the operative phases.

8.1 Date Time

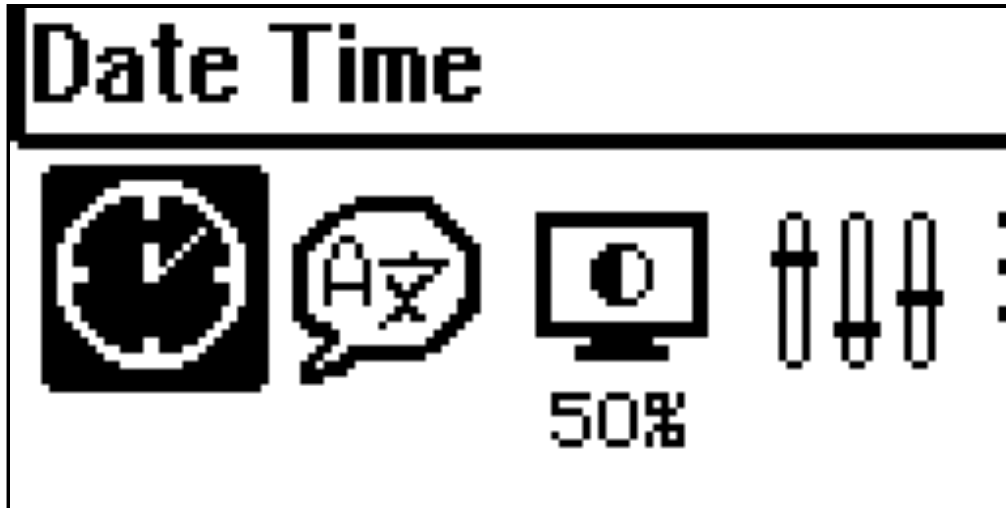

In order to set current Date and Time, use the buttons UP and DOWN to increase/decrease and press ENTER to confirm and skip to the next setting

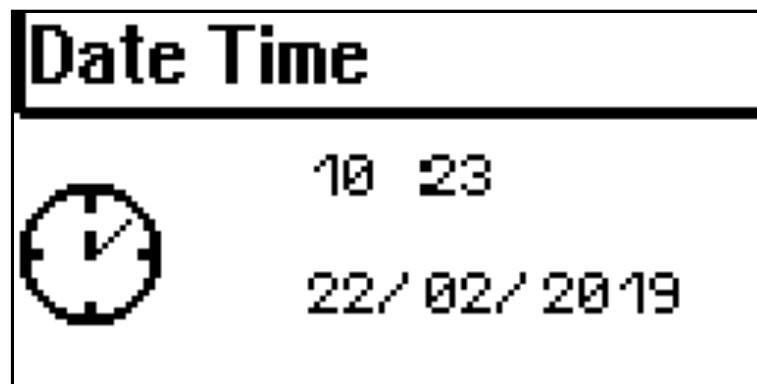

8.2 Language

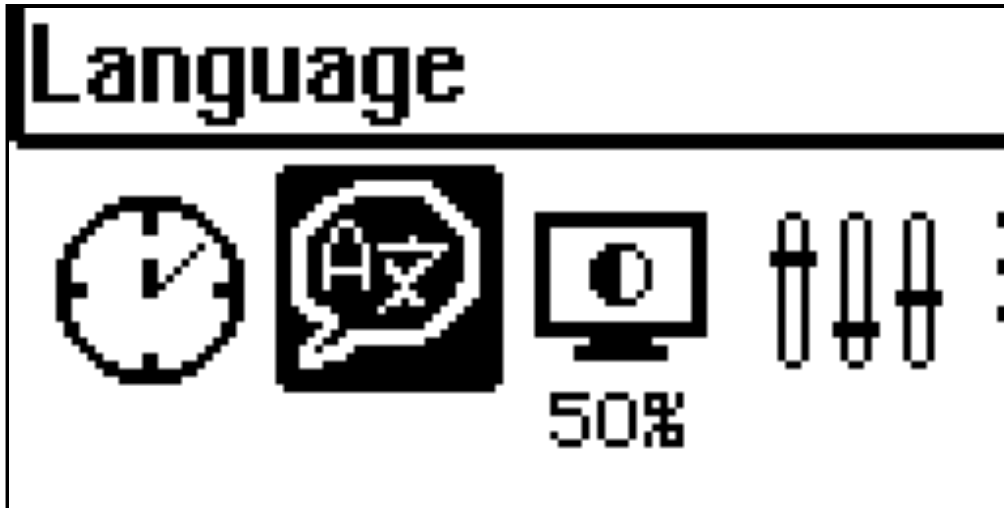

Choose the language to be used by the unit and press ENTER to confirm and exit the setting,



8.3 LCD Setting

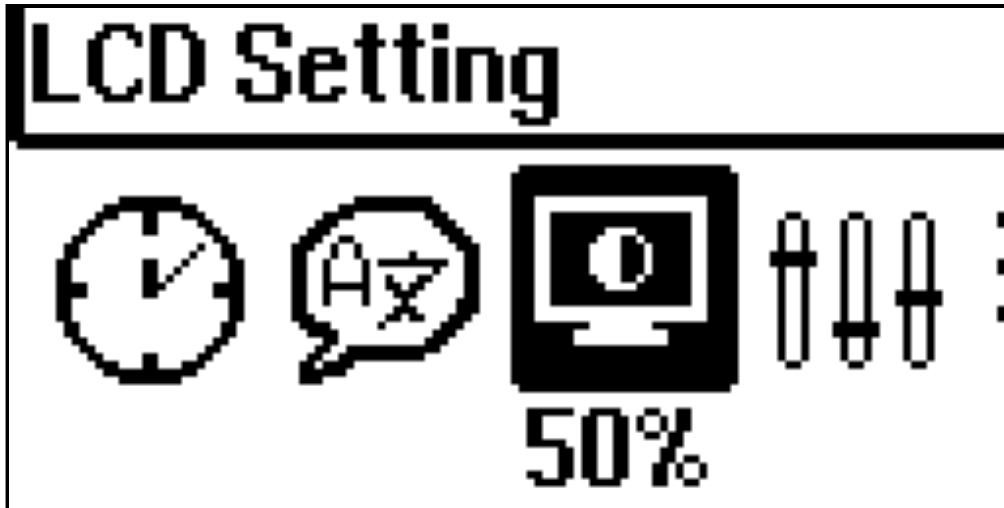

Choose the desired LCD brightness/contrast values with the use of the buttons UP and DOWN and press ENTER to confirm and exit the setting

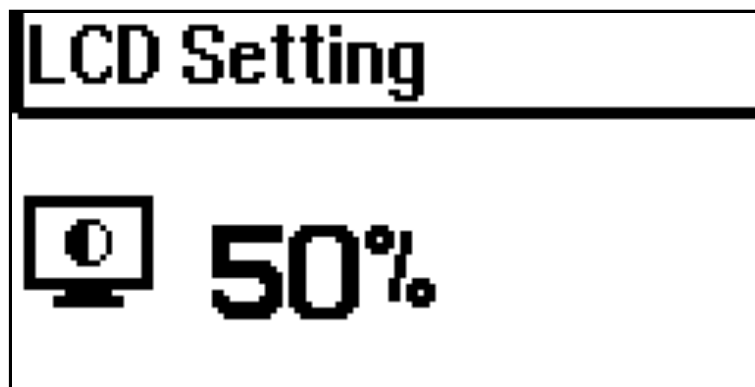

8.4 Working Setup

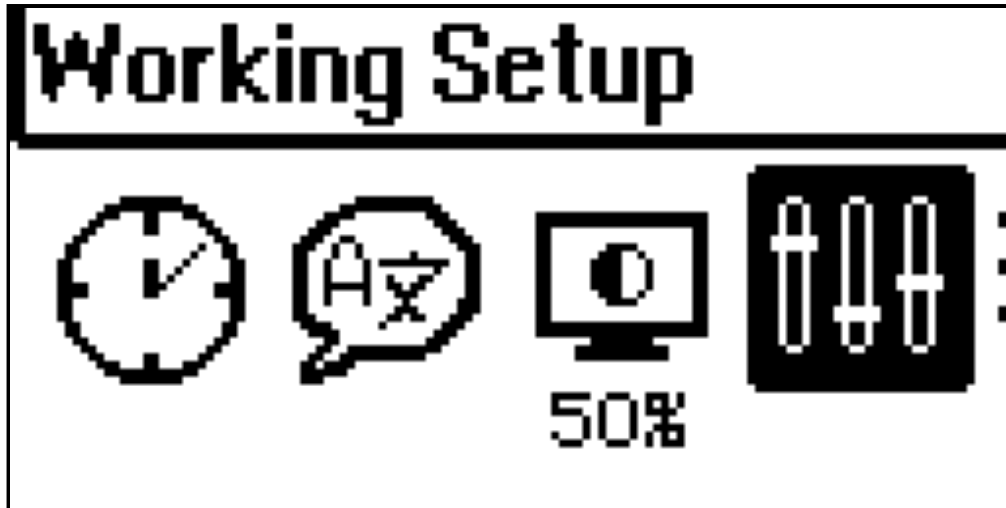

This menu collects a number of setting parameters that allows the user to trim the A/C service cycle depending on his own needs.

This parameters affect both the duration and the accuracy of the service.

It is strongly recommended to read carefully the following paragraphs before changing this values.

8.4.1 Recovery Check

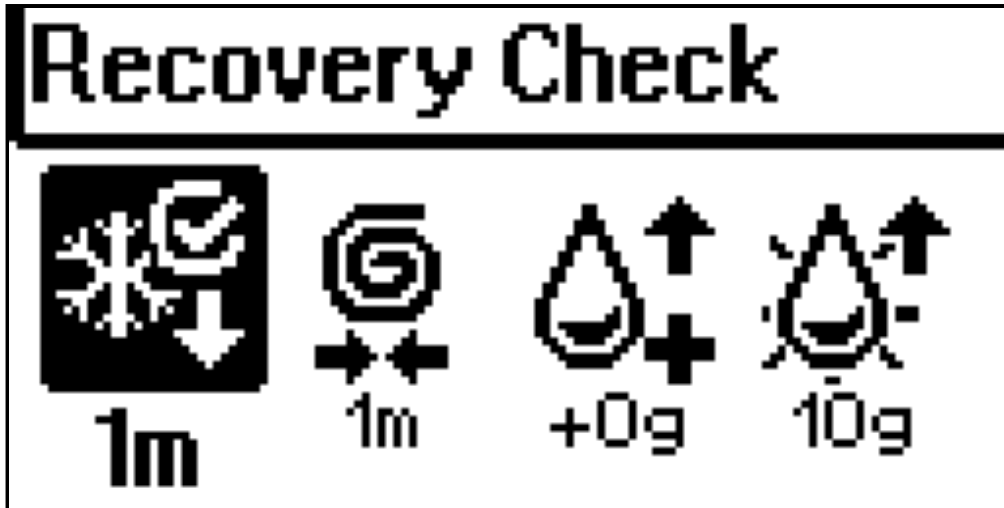

The RECOVERY cycle alternates periods of actual refrigerant recovery during which the internal compressor is switched on, with CHECK periods when the compressor is switched off and the system checks for a eventual pressure rise. Once half of the defined CHECK period has elapsed, if a positive pressure has detected, the compressor start again for a new active recovery phase.



8.4.1 Recovery Check

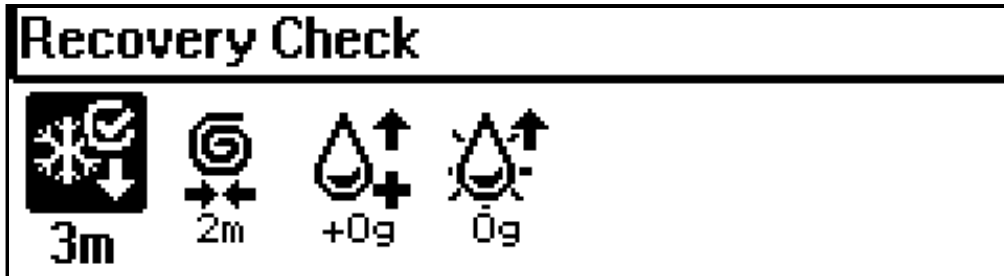

The RECOVERY cycle alternates periods of actual refrigerant recovery during which the internal compressor is switched on, with CHECK periods when the compressor is switched off and the system checks for a eventual pressure rise. Once half of the defined CHECK period has elapsed, if a positive pressure has detected, the compressor start again for a new active recovery phase.

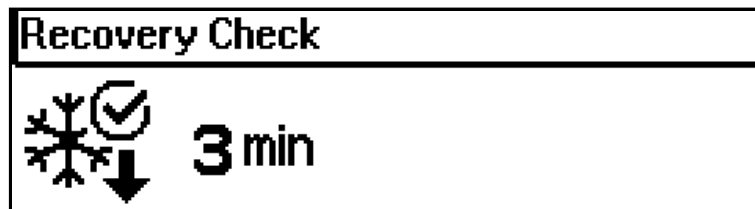

8.4.2 Vacuum Test

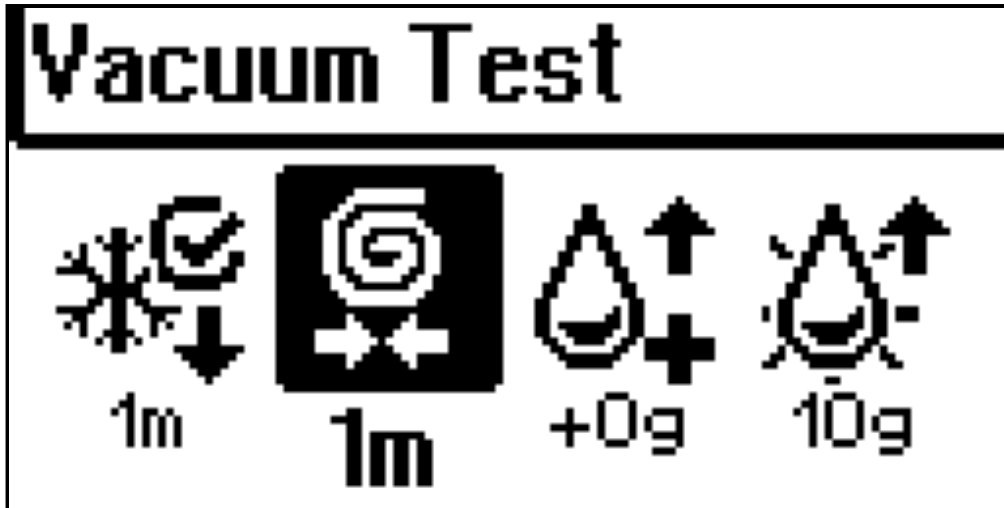

After a VACUUM cycle a VACUUM TEST cycle could automatically be performed. The test checks for the VACUUM pressure will be stable well close to -1000 mbar. The cycle stops in case a significant pressure increase is detected. The parameter defines the duration of the test while a value of zero means the test will be skipped.

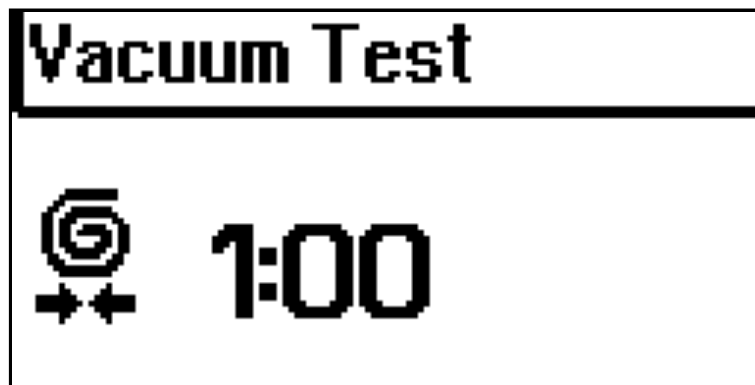

8.4.3 Extra Oil

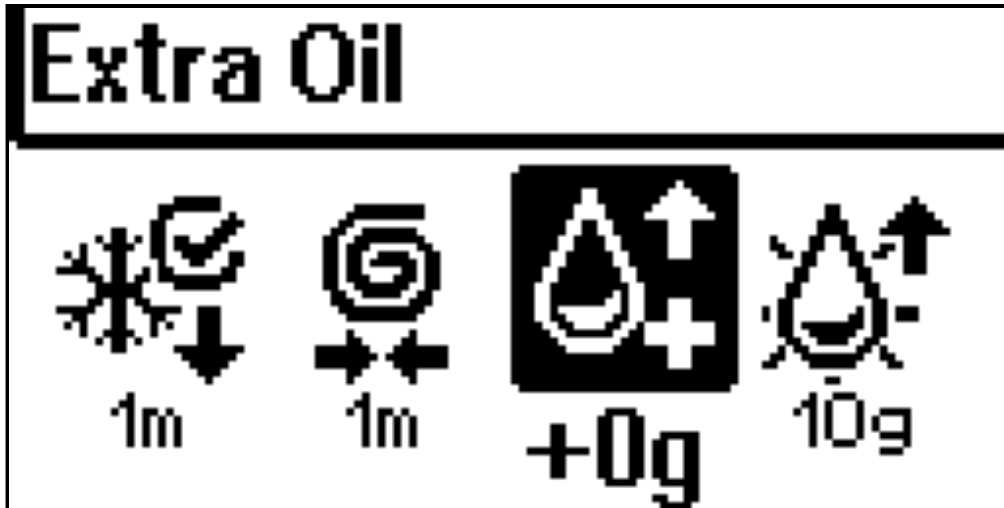

Due to a RECOVERY cycle, some quantity of oil being in the A/C system could be removed and drained as exhaust oil.

The EXTRA OIL parameter defines the mode and quantity of oil injected in the A/C system to restore the original one. Two different modality are available:

The AUTOMATIC WEIGHTED MODE provides to refill as much new oil as it has been drained, eventually increased by a fixed value.

For example an input data value of +10g means the OIL REFILL cycle will refill 10g more than the drained quantity.

The AUTOMATIC PRESET MODE provides a way to refill that new oil quantity regardless of the drained exhaust oil. Set this parameter to "X" in order to set this modality.

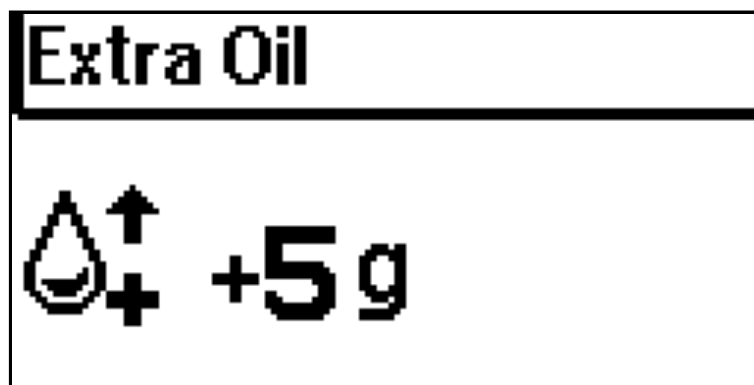

8.5 Hoses Length

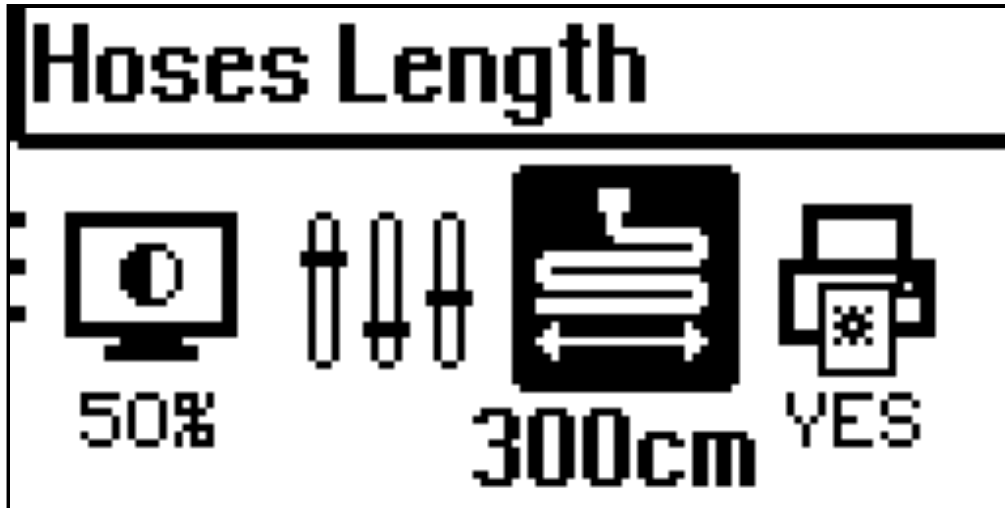

Configure the length of the currently used charging hoses (default length is 3000 cm, which can vary complying to your unit model).

NOTE: if the hose length is set to the correct length of the hoses, the unit will automatically calculate the refrigerant quantity which remains in the charging hoses after the service. These refrigerant residual will be then automatically recovered in the internal tank.

If, on the opposite, the hoses length has been set to "0" the unit will guide the user to recover any gas residuals left in the hoses to the A/C system instead of recovering it into the unit again.

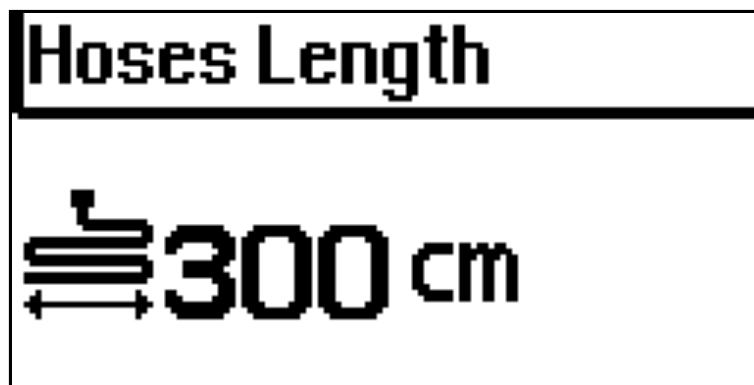

8.6 Print Fluid

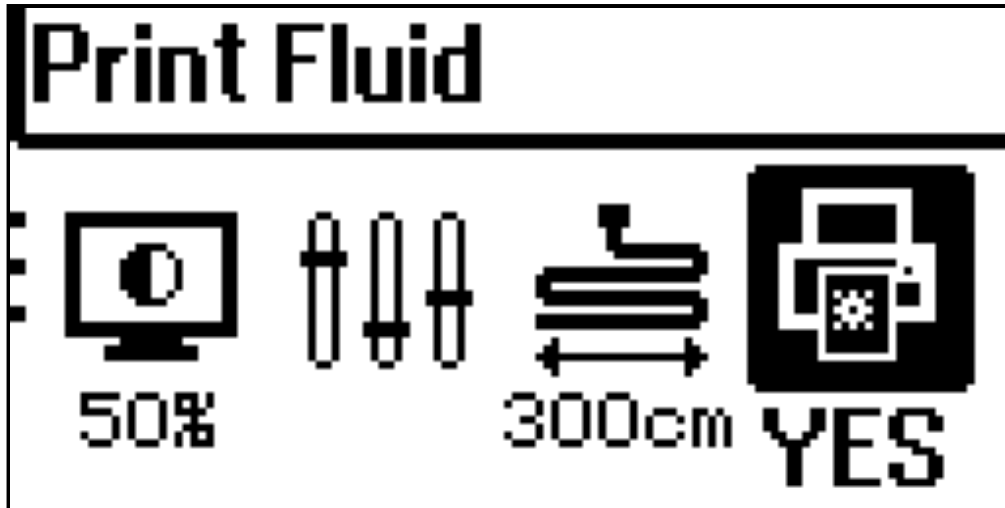

The parameter configures if the refrigerant quantity recovered from the vehicle's A/C system has to be printed (YES/NO). Press ENTER to confirm your choice.

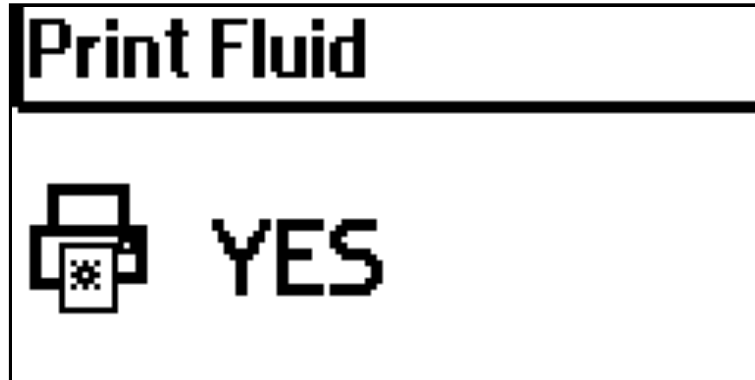

8.8 Info

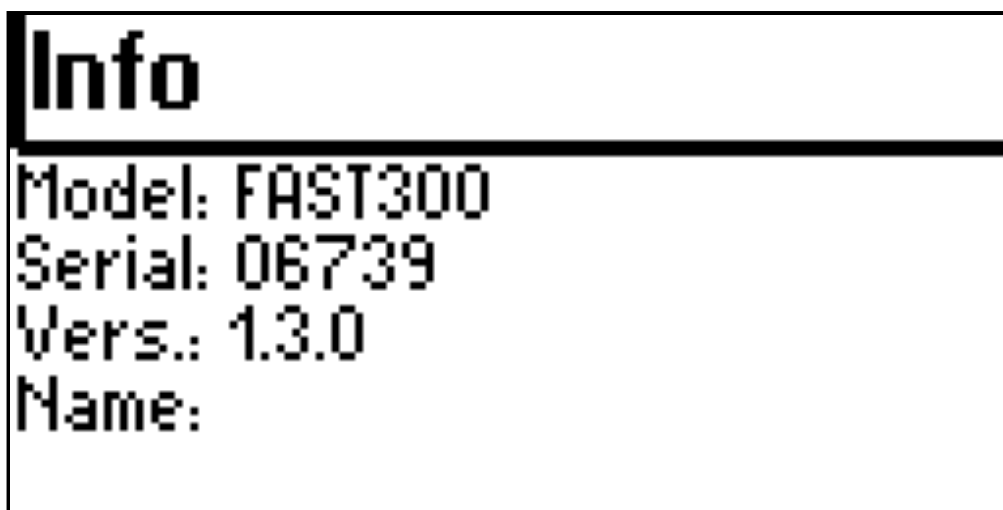

The menu provides a series of information about your unit:

- Model
- Serial number
- FW version
- Name (of the unit to identify the station)

and, on the following page (press INCREASE button to change page):

- Bottle capacity
- Refrigerant in use

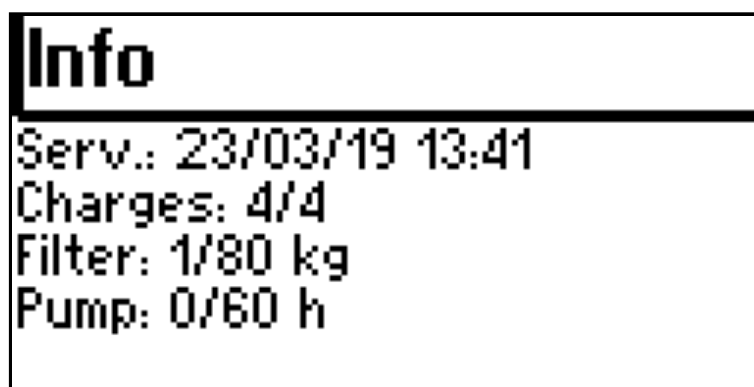

9 Ordinary Maintenance

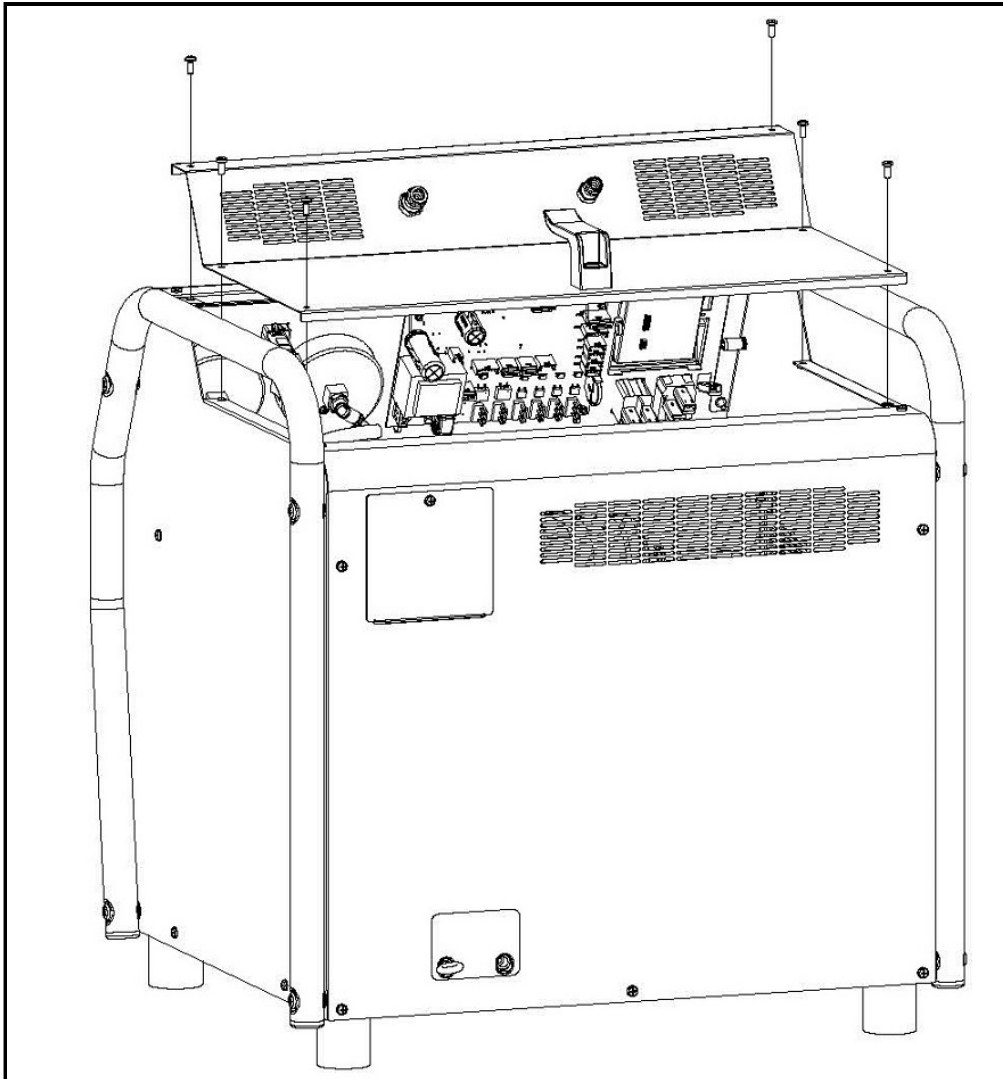

The maintenance has to be carried out by an authorized centre in order to make sure that the warranty of the product is not interrupted. The unit registers service operations in order to monitor the working hours of the filters and the vacuum pump oil . These counters have to be reset by the service personnel.

DEHYDRATING FILTER REPLACEMENT

Replace the filter once a year or when the unit warns you that a change is required. Recover the gas residuals left in the charging hoses and in the filter. Replace with original filters only.

ATTENTION! The filters have to be mounted according to the flow direction indicated by the arrow signed on the filters itself (see drawing)

VACUUM PUMP OIL REPLACEMENT:

Open screw ref.1 and 3 to drain the oil from the pump. Allow the pump to turn for few

seconds in order to drain completely . Fill with oil up to the middle of the sight glas ref. 2
. Turn the pump for few seconds, check if level has changed. Eventually add missing oil.

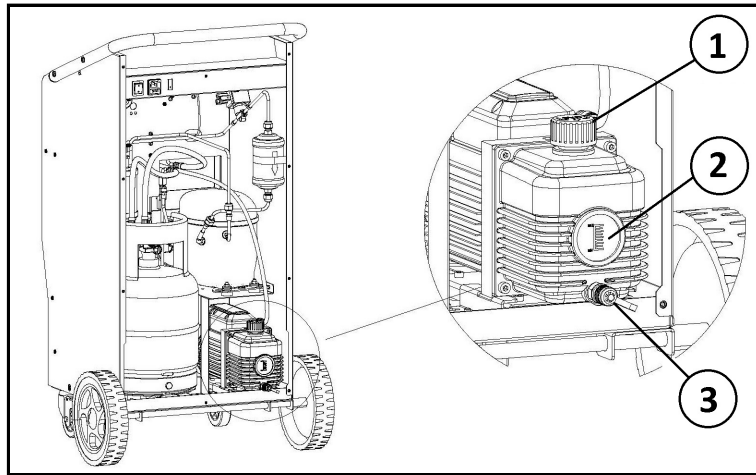

10 CE-Declaration

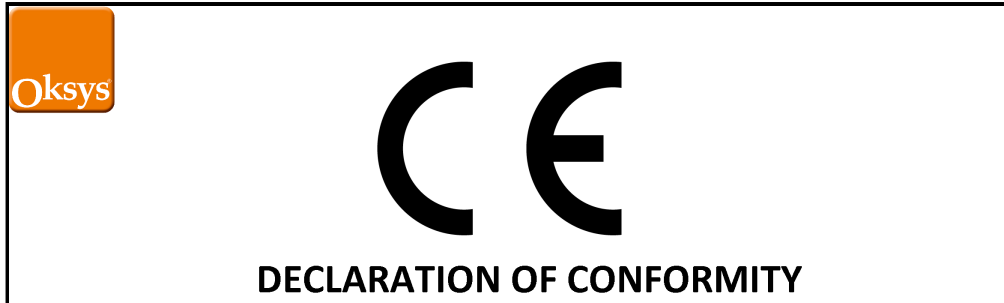

Community directives about Machinery, Low Voltage Electrical Devices and Electro-Magnetic compatibility

OKSYS s.r.l. Via dell'Albereto 33B 50041 CALENZANO (FI) Italy

hereby declares that the following products:

ECOS302 IRC code: SCE302R/SCE302H
FAST302 IRC codes: SCF302R/SCF302H
FAST322 IRC codes: SCF322R/SCF322H
FAST342 IRC codes: SCF342R/SCF342H
AGRICOLD302 IRC codes SCG302R/SCG302H
AGRILITE302 IRC codes: SCR302R/SCR302H
HD302 IRC code:s SCH302R/SCH302H

have been designed, manufactured and distributed meeting in full the essential requirements specified by the following European Directives concerning safety of the machinery, safety of the low-voltage electrical apparatus and electro-magnetic compatibility:

MACHINERY DIRECTIVE 2006/42/CE
LOW VOLTAGE DIRECTIVE 2006/95/CE
ELECTROMAGNETIC COMPATIBILITY DIRECTIVE 2004/108/CE

The conformity is declared with reference to the following harmonized standards

EN61010-1:2010; EN 62233:2008, EN 61000-6-1:2007; EN 61000-6-3:2007;
EN61326-1:2007; EN 61000-3-2:2006/A1:2009; EN 61000-3-3:2008;

The machines are built in accordance to RoHS European Directive requirements.

